

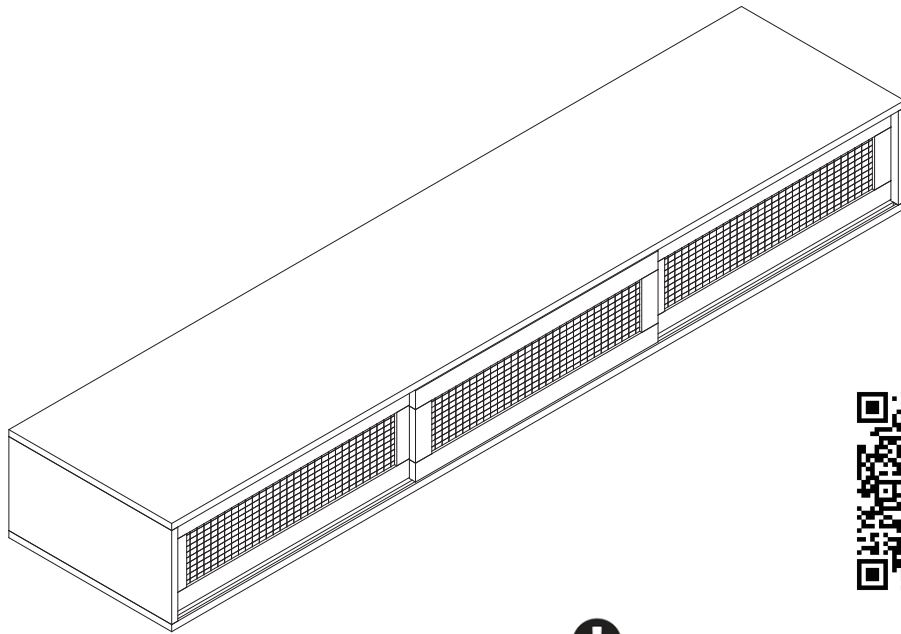

WARNING: Any furniture that is not anchored to a wall has the potential to tip over in certain circumstances, i.e. if a child attempts to climb up on the furniture or in the event of an earthquake. Accordingly, we recommend that all furniture is anchored to a wall.









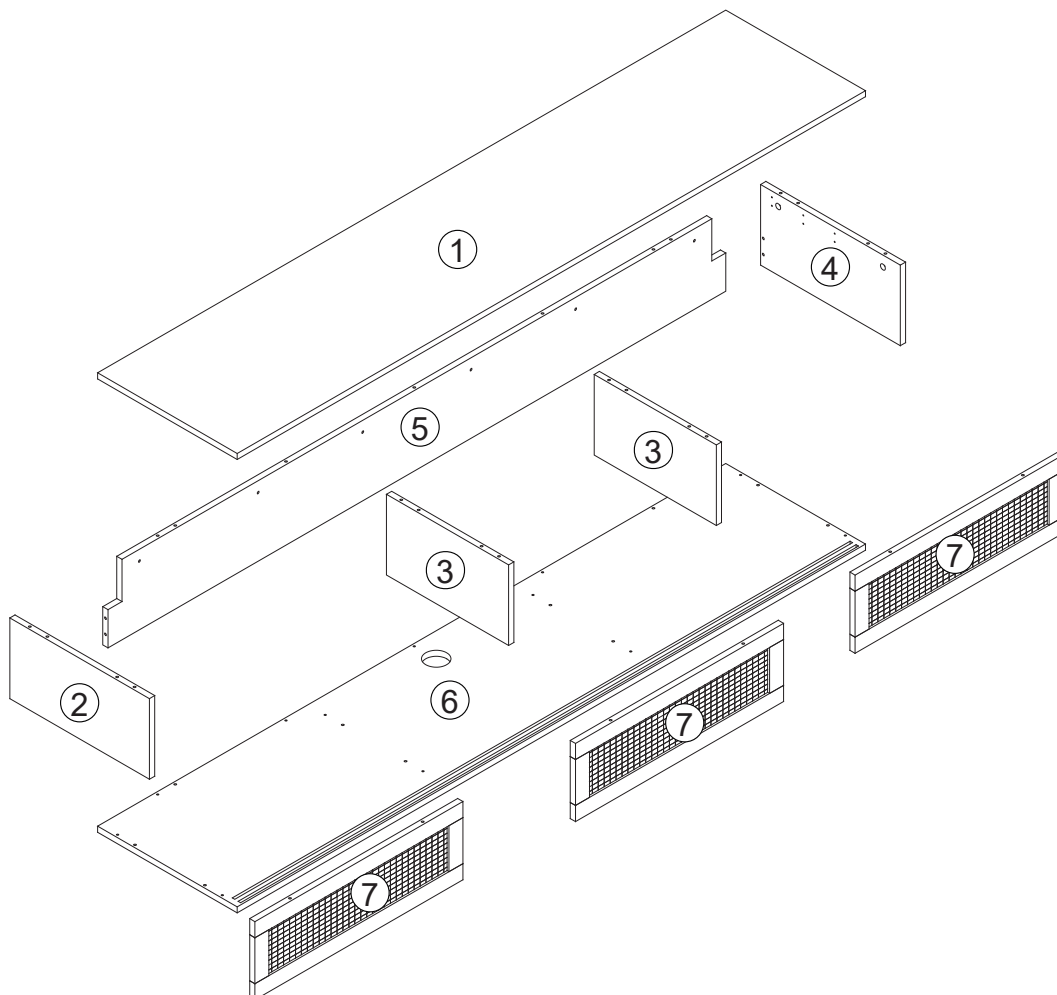

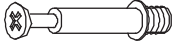
ASSEMBLY INSTRUCTION

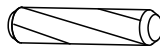
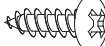
FZ0060085 V. 240807. 01

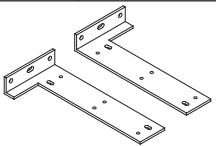

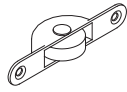
 Scanning the QR code to open assembly instructions.

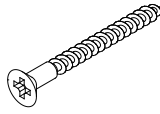
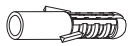

| | | | | | | | | | | | |
|---|-------|---|-------|---|-------|--|-------|---|-------|---|------|
| A | 15PCS | B | 15PCS | C | 20PCS | D | 12PCS | E | 15PCS | F | 1PCS |
|  | |  | |  | |  | |  | |  | |
| G | 6PCS | H | 6PCS | I | 12PCS | J | 10PCS | K | 10PCS | L | 1PC |
|  | |  | |  | |  | |  | |  | |

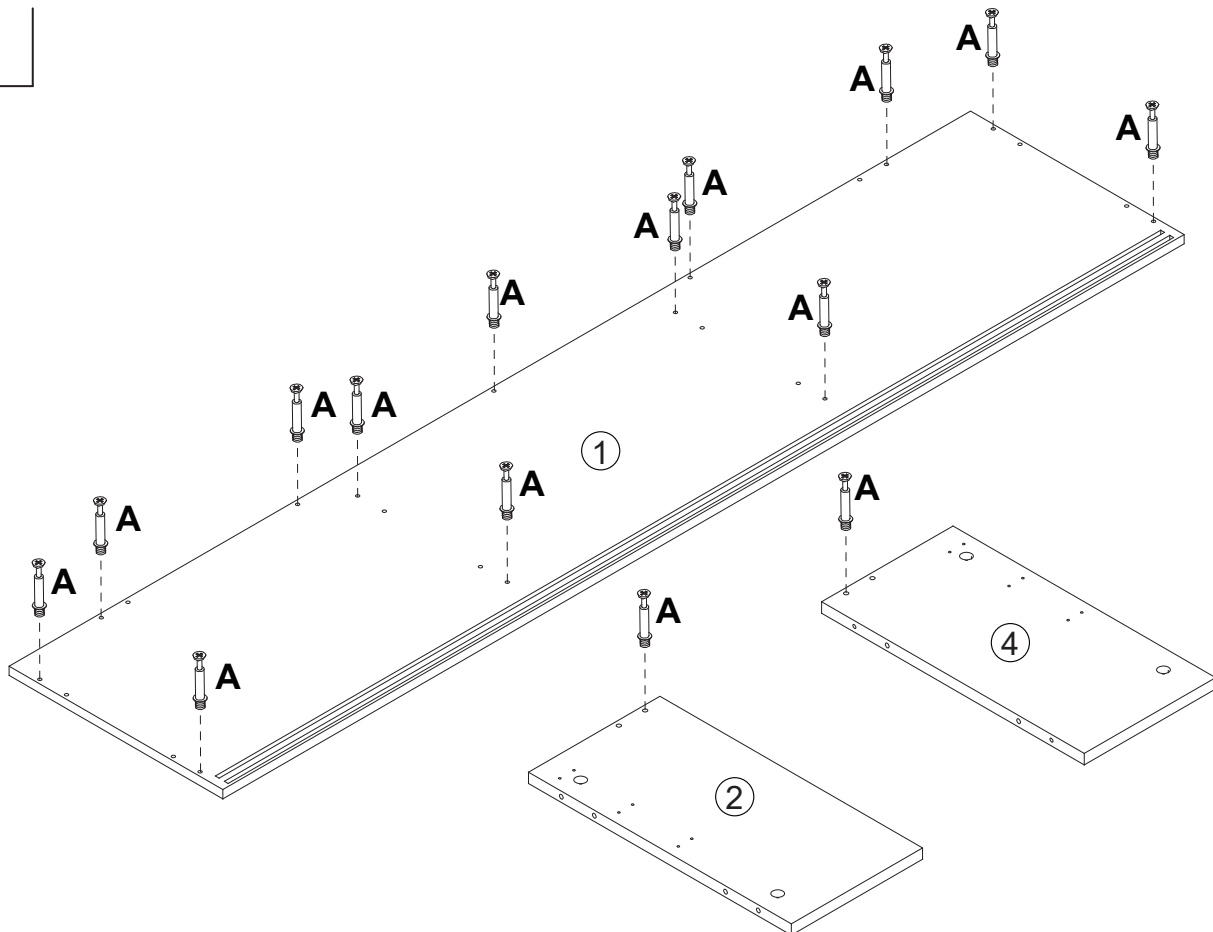

1

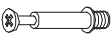

| | |
|---|------|
| A | x 15 |
|  | |

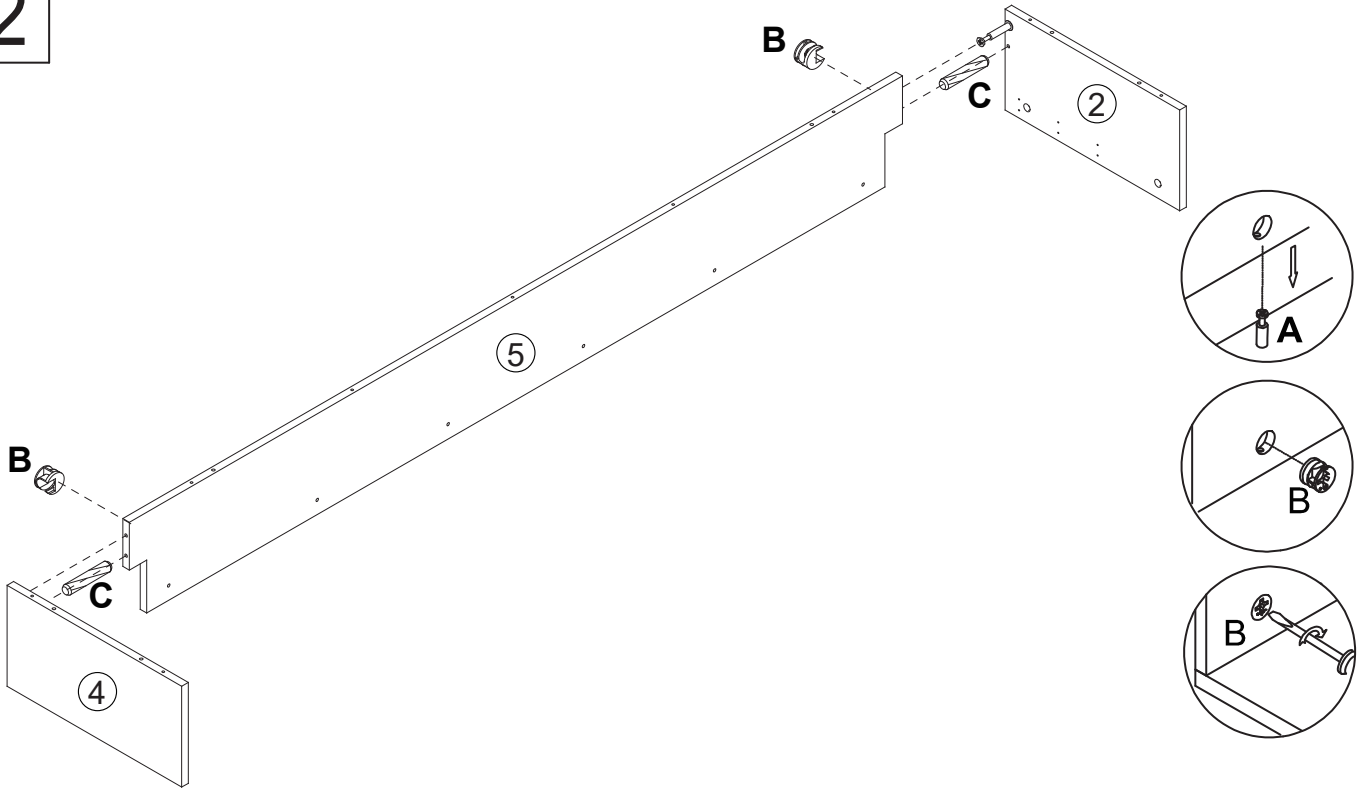

2



| | | | |
|---|----|---|----|
| B | x2 | C | x2 |
|  | |  | |

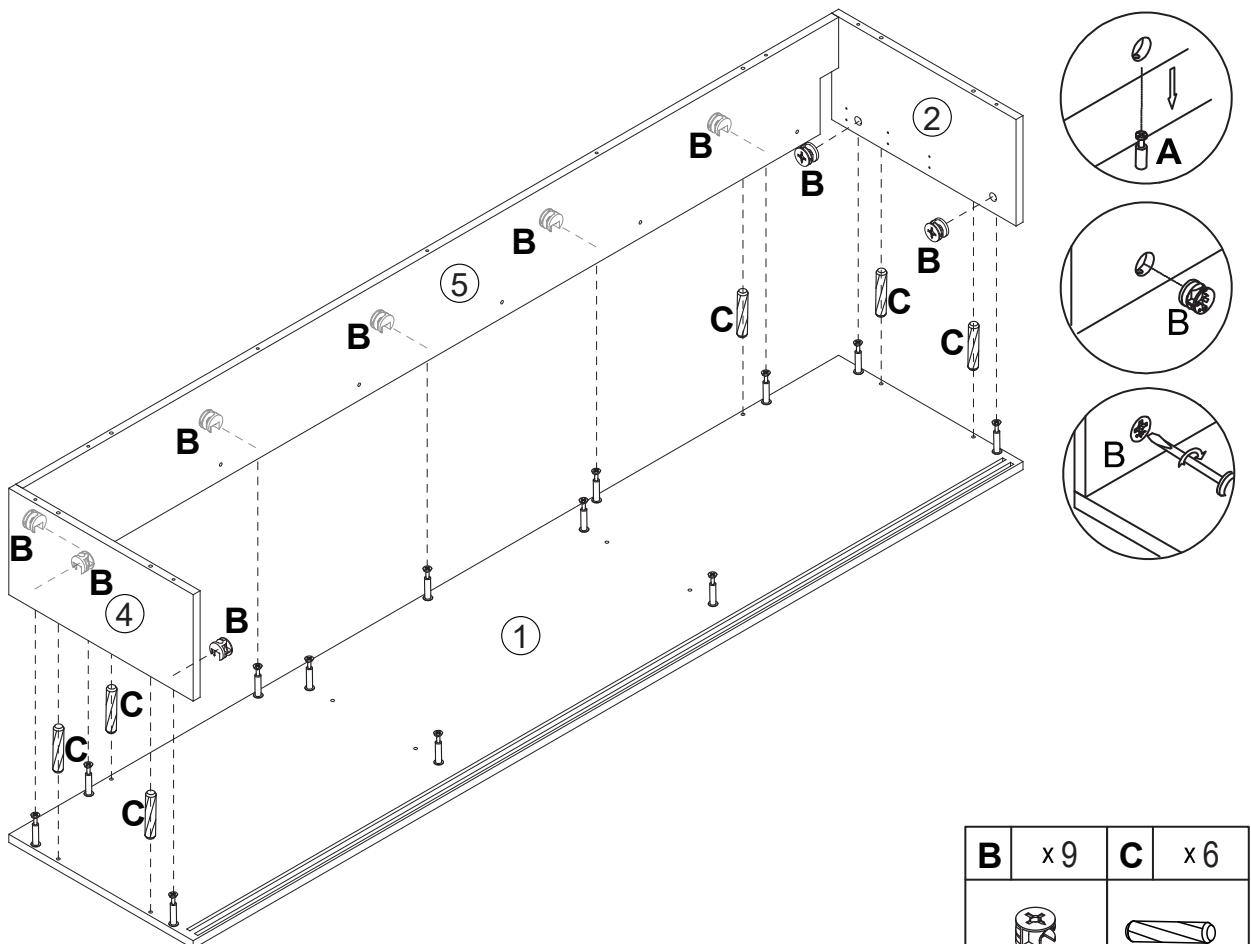

3

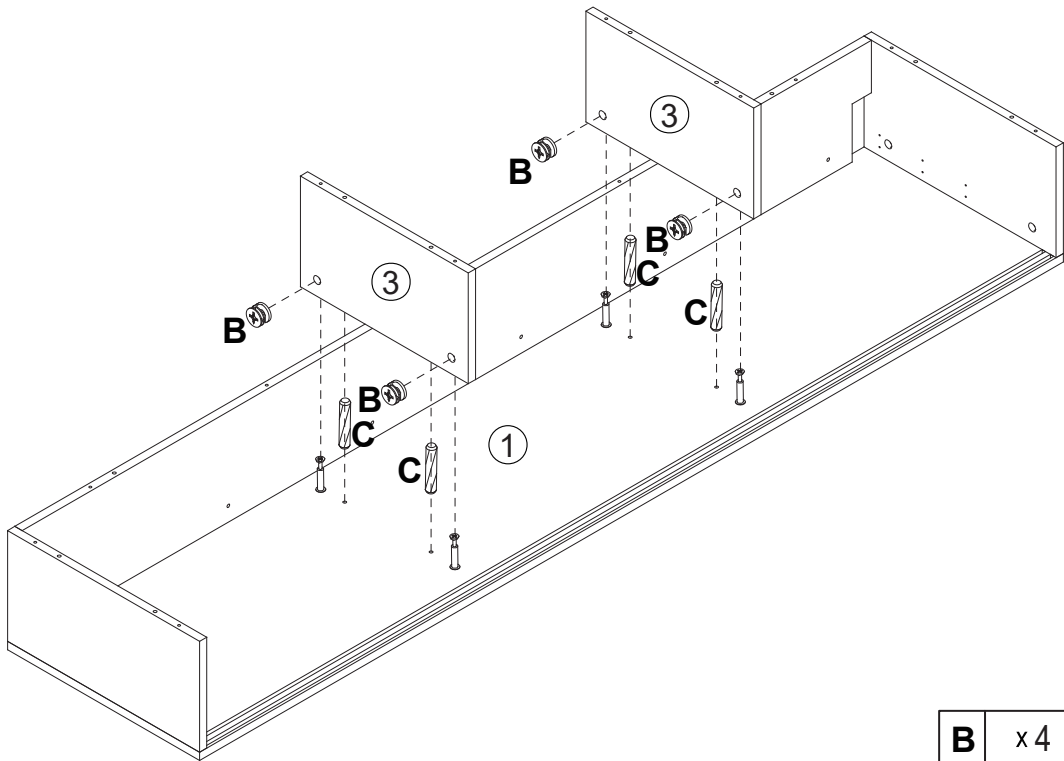
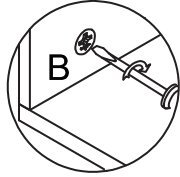
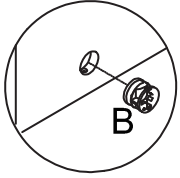
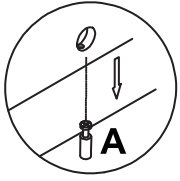

| | | | |
|---|----|---|----|
| B | x9 | C | x6 |
|  | |  | |

4



| | | | |
|---|-----|---|-----|
| B | x 4 | C | x 4 |
|  | |  | |

5

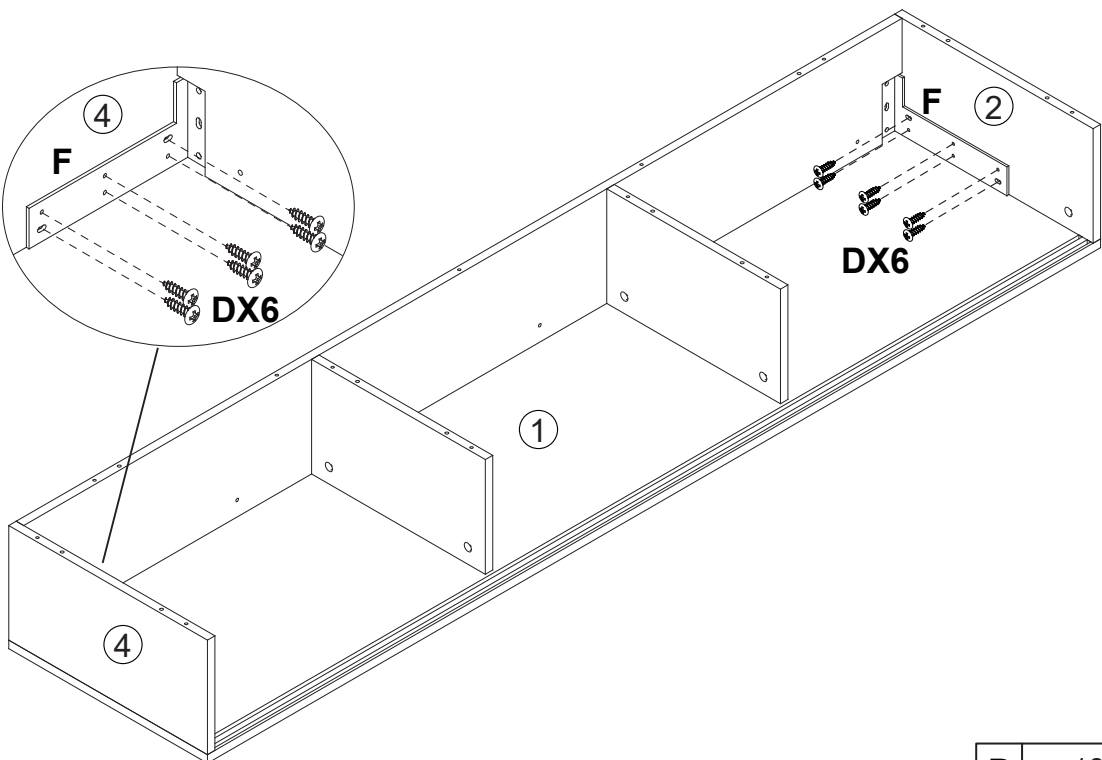
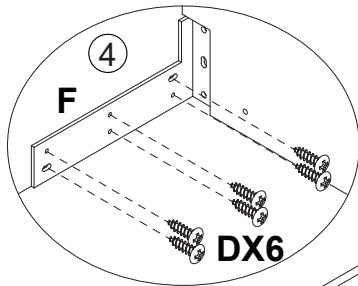

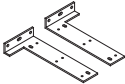
| | | | |
|---|------|---|-----|
| D | x 12 | F | x 1 |
|  | |  | |

6

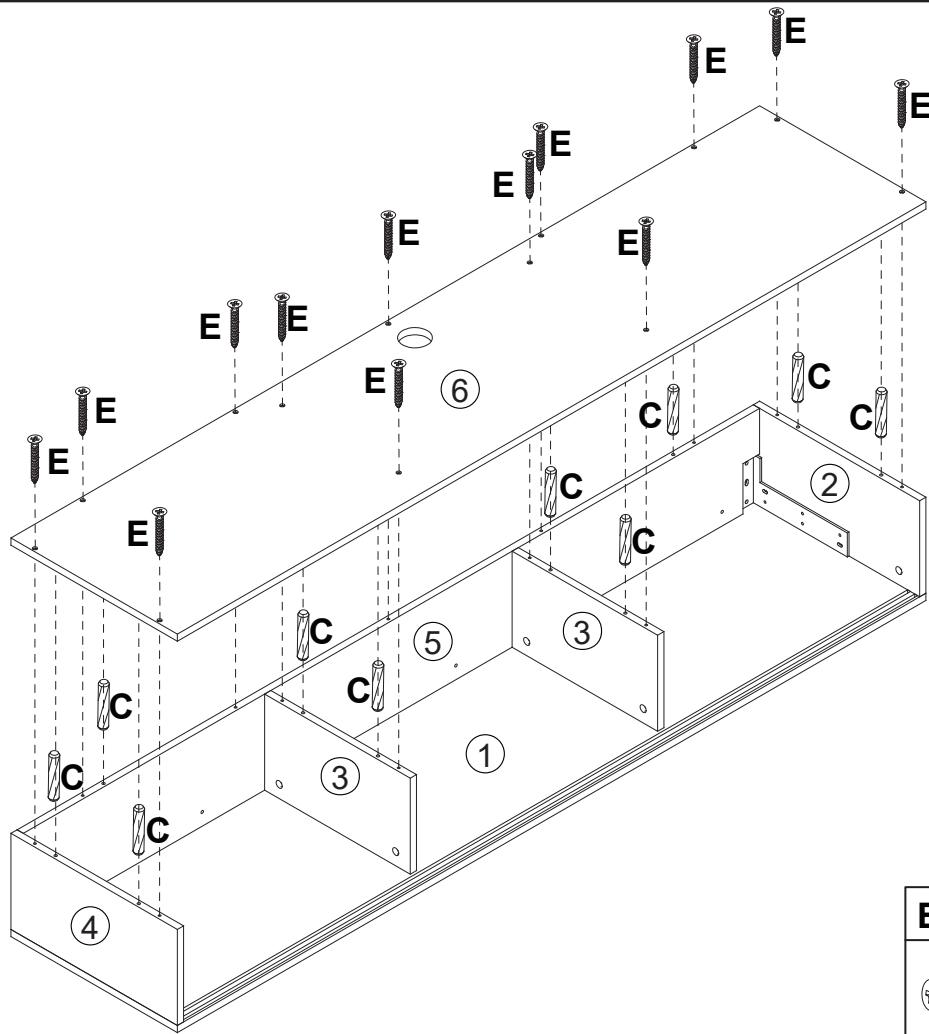

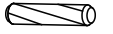
| | | | |
|---|------|---|------|
| E | x 15 | C | x 10 |
|  | |  | |

7

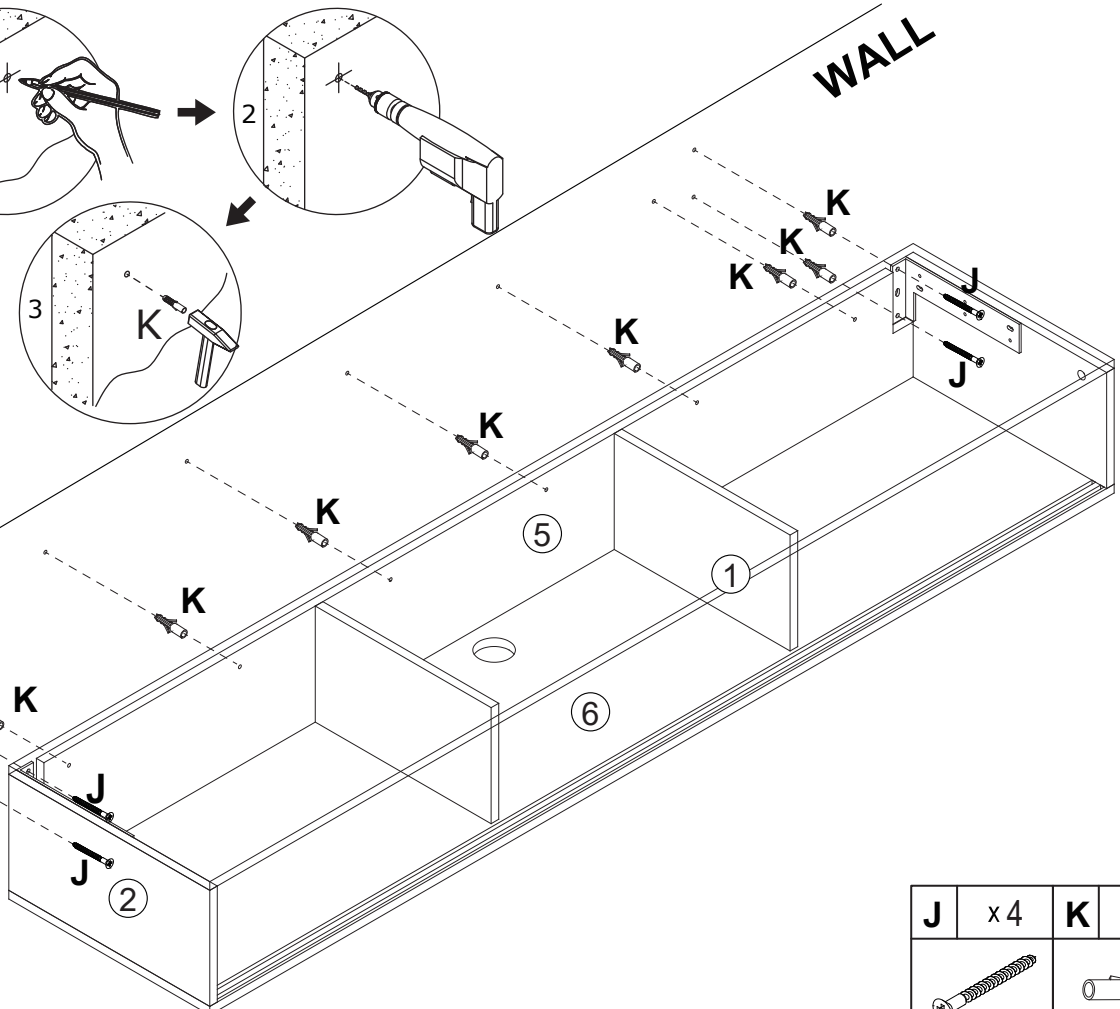
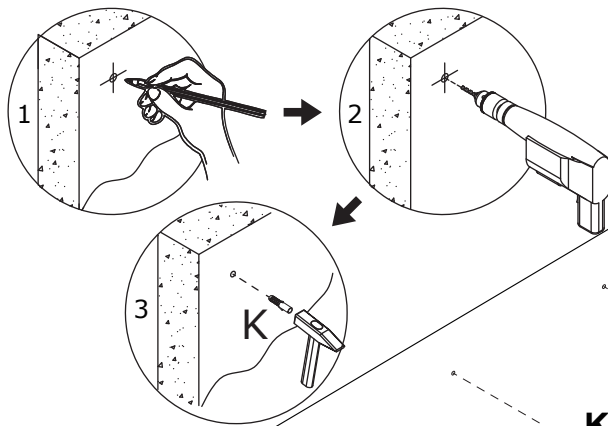

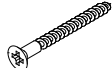
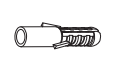

| | | | |
|---|-----|---|------|
| J | x 4 | K | x 10 |
|  | |  | |

8

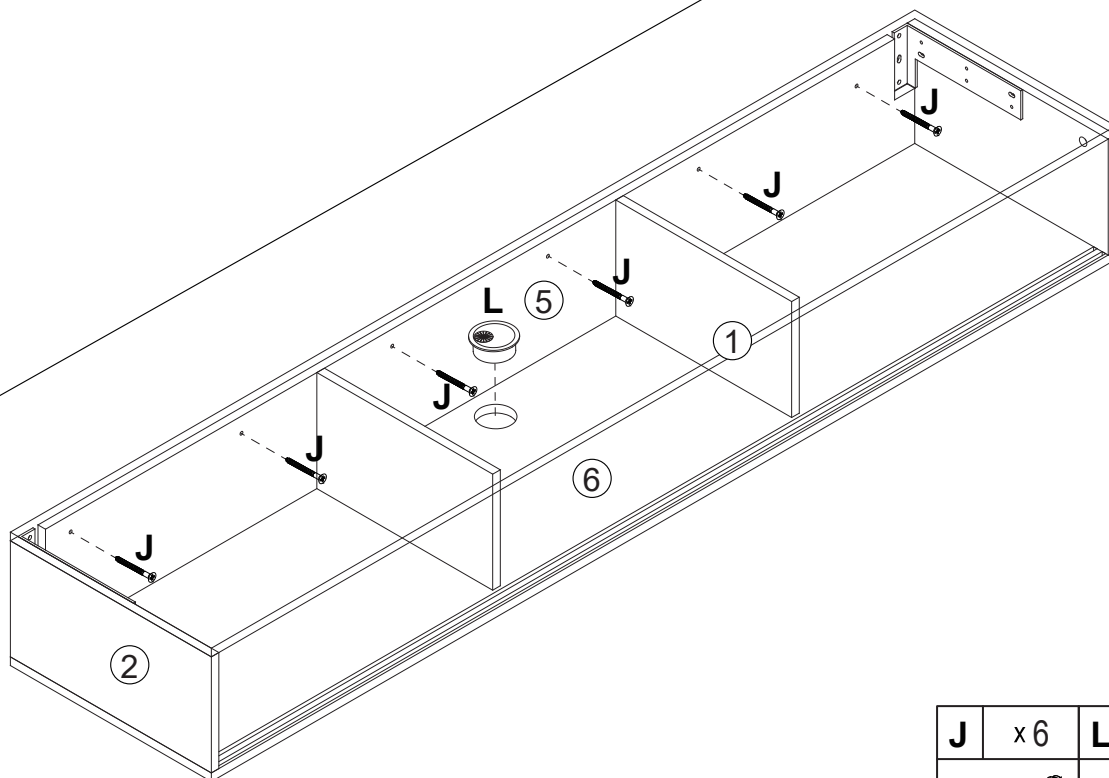
WALL

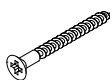

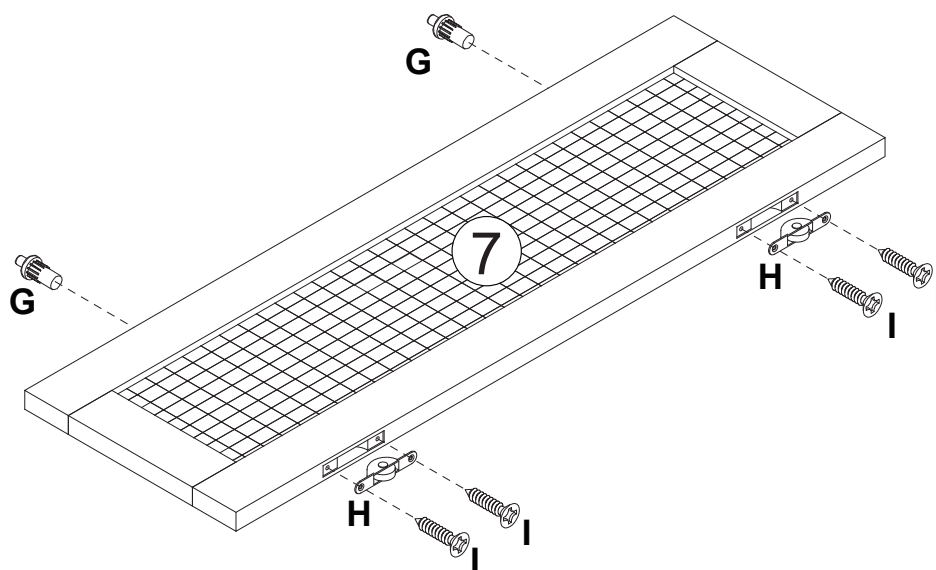

| | | | |
|---|----|---|----|
| J | x6 | L | x1 |
|  | |  | |

9

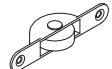

x3

| | | | | | |
|---|----|---|----|---|-----|
| G | x6 | H | x6 | I | x12 |
|  | |  | |  | |

10

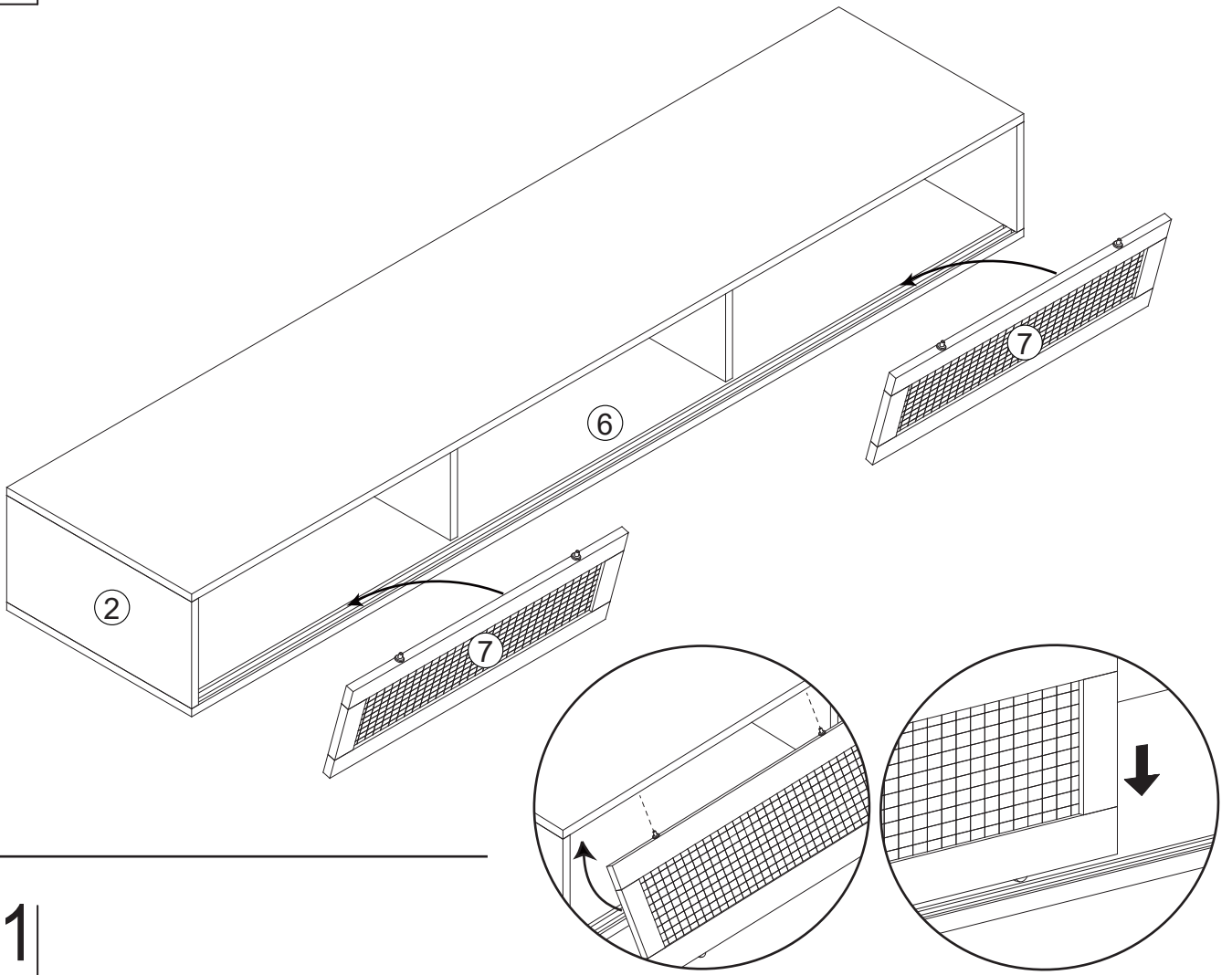

11

